

# Web Development

BSc Applied Computing / Forensics / Entertainment Systems/ IOT

---

Produced  
by

Eamonn de Leastar ([edelestar@wit.ie](mailto:edelestar@wit.ie))

Dr. Brenda Mullally ([bmullally@wit.ie](mailto:bmullally@wit.ie))

Department of Computing, Maths & Physics  
Waterford Institute of Technology

<http://www.wit.ie>

<http://elearning.wit.ie>



Waterford Institute of Technology  
INSTITIÚID TEICNEOLAÍOCHTA PHORT LÁIRCE



# HTML Evolution

---

Enterprise Web development

# 1996

## *Search White House Press Releases, Radio Addresses, Photos and Web Pages*

1. To search White House Press Releases, Radio Addresses, Photos and Web Pages, enter a TERM or PHRASE in the box below which describes your topic of interest (for example, "social security benefits for retired people").

TERM/PHRASE

2. Adjust the START and END dates to limit your search to a specific timeframe. Select from the ITEMS list the number of documents to return from each, then indicate the order in which your results will appear. By "DATE" will return the most recent documents first. By "RELEVANCE" will return the most relevant documents first.

START DATE

ITEMS RETURNED FROM EACH CATEGORY

END DATE

SORT ORDER

DATE  RELEVANCE

Reset this search form

Submit this search form

Start with a new search form





1997

**You can search the White House web site for:**

- [All White House web features combined](#): Press releases, Radio Addresses, photographs and Web Pages.
  - [White House documents](#): Publicly-released documents since the start of the Clinton Administration.
  - [The contents of this web site](#): Just the pages of this service.
  - [Radio Addresses of the President](#): Search and listen to the President's Saturday Radio Addresses.
  - [Executive Orders](#): Official actions, procedural changes, and organizational changes.
  - [White House photographs](#): Search a public collection of photographs.
- You can also search the GovBot database [all government sites](#)

**You can also browse some historic national documents:**

- [The Declaration of Independence](#)
- [The Constitution of the United States of America](#)

If you wish to receive White House publications on a daily basis, you can [subscribe to the publications mailing list](#)

Presidential addresses and the White House press releases may be found in the [Briefing Room](#).



*To comment on this service,  
send feedback to the [Web Development Team](#).*



1998

*Good Morning*



*Welcome to the  
White House*

[Tipper Gore Visits Nicaragua and Honduras](#)



**[The President & Vice President:](#)**

Their accomplishments, their families, and how to send them electronic mail



**[Commonly Requested Federal Services](#)**

Direct access to Federal Services



**[Interactive Citizens' Handbook:](#)**

Your guide to information and services from the Federal government



**[What's New:](#)**

What's happening at the White House -

[President Clinton's Remarks at World AIDS Day Event](#)



**[White House History and Tours:](#)**

Past Presidents and First Families, Art in the President's House and Tours -- [Tour Information](#)



**[Site News:](#)**

Recent additions to our site -

[-Become A White House Fellow](#)

[-Current Competitive Vacancies within EOP](#)

[-Vice President's Welfare-to-Work Coalition](#)

[-White House Millennium Council](#)

1999

Good Evening



## Welcome to the White House

[President Clinton's Trip to New Zealand](#)

[GOP Tax and Budget Plan Could Force Drastic Cuts in Key Programs](#)

[The Urgent National Need For School Construction and Modernization](#)



### [The President & Vice President:](#)

Their accomplishments, their families, and how to send them electronic mail --



[Interactive Citizens' Handbook:](#) Your guide to information about the Federal government



[White House History and Tours:](#) Past Presidents and First Families, Art in the President's House and Tours -- [Tour Information](#)



[The Virtual Library:](#) Search our site, including an extensive archive of White House documents



[White House Help Desk:](#) Frequently asked questions and answers about our service



### [Commonly Requested Federal Services:](#)

Direct access to Federal Services



### [What's New:](#)

What's happening at the White House-

[-Turkey Earthquake Disaster Information](#)

[-Federal Resources for Drought Information](#)

[-President Clinton's Plan to Strengthen Medicare](#)



### [Site News:](#)

Recent additions to our site

[-Office of National AIDS Policy](#)

[-President Clinton's New Markets Tour](#)

[-The President's Trip to Europe](#)

[-White House Millennium Council](#)



### [The Briefing Room:](#)

Today's releases, hot topics, and the latest Federal statistics



### [White House for Kids:](#)

Helping young people become more active and informed citizens



## Welcome To The White House

### **The Clinton/Gore Administration: Fiscal Discipline Produces the Largest Surplus in History**

Tuesday, President Clinton will announce the largest budget surplus and the largest pay-down of debt in American history. [read more](#)

### **President Clinton and Vice President Gore: Modernizing America's Schools**

Tuesday, President Clinton will call on Congress to pass legislation to provide communities new tools to modernize America's schools -- and to do it this year. [read more](#)

### **President Clinton Helps Make Our Roads Safer for American Families**

Monday, President Clinton will sign into law a major safety provision to help set a nationwide impaired driving standard at .08 blood alcohol content (BAC). [read more](#)

### **President Clinton Calls on Congress to Get the Job Done**

Saturday, in his weekly radio address, President Clinton will call on Congress to complete its work and send him a fiscally responsible budget that pays down the debt while investing in America's key priorities -- especially the education of our children. [read more](#)



### **What's New at the White House**

[Millennium Council](#)

### **Recent Additions**

[Radio Address of the President to the Nation - October 21, 2000](#)

2001



# THE WHITE HOUSE

President  
News  
History  
For Kids  
Tours  
Your Government  
Appointments

Contact  
Text  
Help

Search



## Special Events



[Opening Day Photos  
of Tee Ball at the  
White House](#)



America's 43<sup>rd</sup> President, George W. Bush, and First Lady Laura Bush welcome you to the White House.

## In Focus

- [President's Radio Address to the Nation](#)



[President Bush Names Director of the Office of Drug Control Policy](#)

- [Listen to the President's Remarks](#)

- [President Bush Releases Budget](#)



[Interactive Map: See How the Budget Affects Your State](#)

[ [Privacy Policy](#) | [Text Only](#) | [Help](#) ]



2002

### West Wing connections

#### Policies in Focus

- National Security
- Homeland Security
- Economic Security
- More Issues
- En Español

#### News

- Current News
- Video
- Press Briefings
- Proclamations
- Executive Orders
- Radio Addresses

#### Appointments

- Nominations
- Application

#### Offices

- Freedom Corps
- Faith-Based & Community
- OMB
- More Offices

#### Major Speeches

- Iraqi Threat
- U.N. Remarks
- September 11, 2002 Remarks
- Homeland Security Department
- Compassionate Conservatism

#### Photos



- Photo Essays

Today at the White House, Dec. 2, 2002

### Radio Address by the President to the Nation

Good morning. This week all across America we gather with the people we love to give thanks for the blessings in our lives. Each family has its own traditions, yet we are united as a nation in setting aside a day of gratitude. We are grateful for the freedoms we enjoy, grateful for the loved ones who give meaning to our lives, and grateful for the many gifts of this prosperous land. On Thanksgiving we acknowledge that all of these things, and life itself, come not from the hand of man, but from Almighty God. [full story](#) [en Español](#)

◀ Audio

### President's Hanukkah Message

President Bush Friday said, "Americans join in thanking God for our blessings and renew our commitment to the values of faith, family, and community that make us strong. The candles of Hanukkah remind us that in the face of darkness, goodness will prevail." [full story](#)

### President Condemns Attacks

President Bush on Thursday said, "I condemn, in the strongest possible terms, the terrorist attacks today at the Likud Party polling place in northern Israel and the Paradise Hotel in Mombasa Kenya, as well as the attempted attack on a civilian airliner shortly after it took off from Mombasa's international airport." [full story](#)

### President Gives "Web-Exclusive" Video Tour of the Oval Office



The White House unveiled *Life in the White House*, a new feature on this web site showcasing web-exclusive video tours of the White House led by President Bush, Vice President Cheney, Laura Bush, Lynne Cheney



White House photo by Paul Morse

President George W. Bush talks with some of family members of those who were killed during the September 11 attacks after signing Intelligence Authorization Act in the Roosevelt Room, Wednesday, Nov. 27. The act of Congress will authorize intelligence programs and creating a national commission to investigate the events of September 11, 2001.

#### Life in the White House [More ▶](#)

##### Life in the White House

Life in the White House offers the American people a "birds-eye" view of the people and places making history today and in years past, exclusively on the White House web site.



#### Iraq Update [More ▶](#)

##### Saddam Hussein's Iraq

For more than a decade, Saddam Hussein has deceived and defied the will and resolutions of the U.N. Security Council.



#### 3 Video Headlines [More ▶](#)

##### President Bush Signs Homeland Security Act

President Bush signed the Homeland Security Act establishing the Department of Homeland Security.





2003

**In Focus**

- Medicare
- Iraq
- National Security
- Economic Security
- Homeland Security
- More Issues
- En Español

**News**

- Current News
- Video
- Press Briefings
- Proclamations
- Executive Orders
- Radio Addresses

**Appointments**

- Nominations
- Application

**Offices**

- Global Communications
- USA Freedom Corps
- Faith-Based & Community
- OMB
- More Offices

**Major Speeches**

- UN Address
- National Address
- Iraqi Freedom
- National Address
- State of the Union

**Photos**



▪ Photo Essays

December 5, 2003 | Last Updated 2:04 a.m. (EST)

**Remarks by the President at the Pageant of Peace**

President Bush on Thursday said, "This evening, we continue a tradition in Washington as we gather to light the National Christmas Tree." [full story](#)

**President Bush Signs Identity Theft Legislation**



Play Video ▶

President Bush on Thursday said, "With this legislation, the federal government is protecting our citizens by taking the offensive against identity theft." [full story](#)

- [Fact Sheet](#)
- [Treasury Secretary Discusses Identity Theft](#)

**Treasury Secretary John Snow Discusses Identity Theft**



Treasury Secretary John Snow on Thursday answered your questions on identity theft and steps the Bush Administration is taking to crack down on this crime. [Click here](#) to read the transcript. [full story](#)

**Senior Advisor to Iraqi Ministry of Health Discusses Progress in Iraq**



James Haveman, Senior Advisor to Iraqi Ministry of Health, on Thursday discussed progress in the Iraq public health system. [Click here](#) to read the transcript. [full story](#)

**President's Statement on Steel**

President Bush on Thursday said, "Today, I

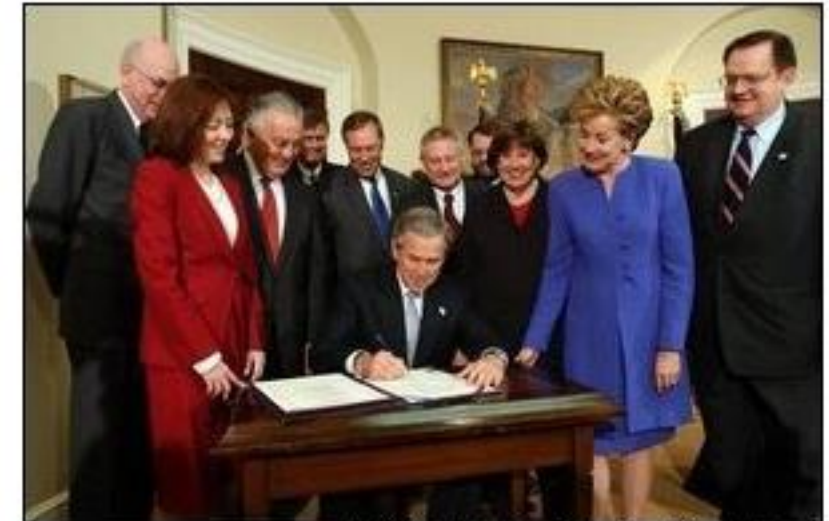

White House photo by Tina Hager

President George W. Bush signs H.R. 2622, the Fair and Accurate Credit Transactions Act of 2003, into law during a ceremony in the Roosevelt Room Thursday, December 4, 2003.

[View webcast ▶](#)

**Ask the White House** [More ▶](#)

**President's Economic Advisor Greg Mankiw to Discuss Economy**

Greg Mankiw, Chairman of the Council of Economic Advisers, will discuss the latest economic numbers Friday at 10:45am. [Submit a question.](#)



**The Healthy Forests Initiative** [More ▶](#)

On December 3, President Bush signed into law the Healthy Forests Restoration Act of 2003 to reduce the threat of destructive wildfires while upholding environmental standards and encouraging early public input during review and planning processes. [More...](#)



**IRAQ Progress in Iraq** [More ▶](#)

**Progress in Public Health Care**

All 240 hospitals in the country are open and providing services as well as the 1200 primary health care centers. [More...](#)



**THANKSGIVING AT THE WHITE HOUSE** [More ▶](#)



2004



# The White House

PRESIDENT GEORGE W. BUSH

President \* News \* Vice President \* History & Tours \* First Lady \* Mrs. Cheney

YOUR GOVERNMENT KIDS ESPAÑOL CONTACT PRIVACY POLICY SITE MAP SEARCH



EMAIL UPDATES

SEARCH

## Issues

- Economy
- Iraq
- Education
- National Security
- Homeland Security
- More Issues
- En Español
- Hurricane Relief

## News

- Current News
- Press Briefings
- Proclamations
- Executive Orders
- Radio

## Talk Back

- Ask the White House
- White House Interactive

## Appointments

- Nominations
- Application

## Offices

- Global Comm
- Freedom Corps
- Faith-Based & Community
- OMB
- More Offices

## Major Speeches

- Remarks with PM Blair
- Honoring Veterans
- Press Conference
- Acceptance Speech

- Photo Essays
- Search photos by date

November 20, 2004 | Last Updated 3:31 a.m. (EST)

## President Bush Nominates Margaret Spellings as Secretary of Education



Play Video ▶

President Bush on Wednesday said, "In Margaret Spellings, America's children, teachers and parents will have a principled, determined ally in my Cabinet. She has my complete trust and she will be an outstanding Secretary of Education." [full story](#)

## President Bush Names Harriet Miers as Top Counsel

President George W. Bush on Wednesday announced his intention to appoint Harriet Miers to be Counsel to the President. Ms. Miers will fill the position held by Judge Alberto Gonzales, following his confirmation by the Senate. [full story](#)

## President's Remarks at the Clinton Presidential Center Dedication

President Bush on Thursday said, "Laura and I are really pleased to be a part of this happy and historic occasion. On this day of dedication, we honor the man from Hope, Arkansas, who became the 42nd President of the United States." [full story](#)

## President Pardons "Biscuits and Gravy" in Annual Turkey Ceremony



Play Video ▶

President Bush on Wednesday said, "The National Thanksgiving Turkey will soon be on stage for all to see, but he's not going to end up on the table. I'm granting him a Presidential

Pardon." [full story](#)

In Focus: Thanksgiving 2004



More Photos

White House photo by Eric Draper

As pictured on an outdoor video screen, President George W. Bush addresses attendees during the dedication of former President Bill Clinton's Presidential Center and Park in Little Rock, Ark., Nov. 18, 2004. "He was a tireless champion of peace in the Middle East. He used American power in the Balkans to confront aggression and halt ethnic cleansing. And in all his actions and decisions, the American people sensed a deep empathy for the poor and the powerless," said President Bush.

## Ask the White House

More ▶

### White House Turkey Guy on Ask

The White House Turkey guy (Christopher Smith) answered your questions on the annual pardoning of the Thanksgiving Turkey on Wednesday. Read the Full Transcript.



## THANKSGIVING AT THE WHITE HOUSE

More ▶

### Gobble the Vote

The public has spoken and the names for this year's Thanksgiving Turkey and runner up have been selected. Your vote made a difference. [Click here](#) to watch the ceremony and to learn more about the annual ceremony.



## WHITE HOUSE INTERACTIVE

More ▶

### Email the White House...

Q: David from Massachusetts:  
CONGRATULATIONS MR. PRESIDENT!!!!!!  
YAHOO!!!!!!



2005

**Issues**

- Hurricane Relief
- Homeland Security
- Judicial Nominations
- National Security
- Renewal in Iraq
- Jobs & Economy
- Social Security
- [More Issues »](#)

**News**

- Current News
- Press Briefings
- Proclamations
- Executive Orders
- Radio

[RSS Feeds](#)

**Major Speeches**

- Hurricane Relief
- War on Terror
- Energy Act
- Second Term Agenda

**Interact**

- Ask the White House
- White House Interactive

**Your**

**Government**

- President's Cabinet
- USA Freedom Corps
- Faith-Based & Community
- OMB
- NSC
- [More Offices »](#)

**Appointments**

- Nominations
- Application



December 21, 2005 | Last Updated 1:42 a.m. (EST)

**President Attends Swearing-In of Millennium Challenge CEO**



[Play Video ▶](#)

President Bush on Tuesday said, "Almost two years ago, we launched the Millennium Challenge Account as an entirely new way to provide aid. The MCA is based on clear principle: countries that seek our aid must demonstrate a record of performance. ... John Danilovich is the right person to take on this part of our efforts to fight poverty." [full story](#)

**Press Briefing by Scott McClellan**



[Play Video ▶](#)

Watch Tuesday's Press Briefing with White House Press Secretary Scott McClellan. [full story](#)

**Service During the Holidays Discussed**



Desiree Sayle, Deputy Assistant to the President and Director of USA Freedom Corps, discussed how Americans can engage in volunteer service and care for a neighbor in need this holiday season

Tuesday. [Read the full transcript.](#)

**Press Conference of the President**



[Play Video ▶](#)

President Bush on Monday said, "This new threat required us to think and act differently. And as the 9/11 Commission pointed out, to prevent this from happening again, we need to connect the dots before the enemy attacks, not after. And we need to recognize that dealing with al Qaeda is not simply a matter of law enforcement; it requires defending the country



**More Photos** White House photo by David Bohrer  
 Vice President Dick Cheney discusses earthquake relief efforts with Pakistani President Pervez Musharraf, Tuesday Dec. 20, 2005. President Musharraf thanked the Vice President for the US relief assistance and said, "I don't think we could have managed the relief operation without your support." White House photo by David Bohrer

**RENEWAL IN IRAQ**

**Strategy for Victory in Iraq**

On Sunday, during a LIVE Address to the Nation from the Oval Office, President Bush discussed the strategy to help the Iraqi people defeat the terrorists and build an inclusive democratic state. [Click here to learn more.](#)



**ASK THE WHITE HOUSE**

[More ▶](#)

**Saddam Hussein Trial**

Christopher Reid, Regime Crimes Liaison, U.S. Embassy in Iraq, will discuss Saddam Hussein's trial for crimes against humanity Wednesday at 1 PM ET. [Submit a question.](#)



**HOMELAND SECURITY**

**Renewing the Patriot Act**

The Patriot Act is vital tool that law enforcement and intelligence officials have used to protect the American people. The President calls on the Senate to renew the provisions within the Patriot Act that are set





2006

**Issues**

- [Budget Management](#)
- [Education](#)
- [Energy](#)
- [Health Care](#)
- [Homeland Security](#)
- [Hurricanes](#)
- [Immigration](#)
- [Jobs & Economy](#)
- [Judicial Nominations](#)
- [Medicare](#)
- [Middle East](#)
- [National Security](#)
- [Pandemic Flu](#)
- [Patriot Act](#)
- [Renewal in Iraq](#)
- [Social Security](#)
- [More Issues](#)

**News**

- [Current News](#)
- [Press Briefings](#)
- [Proclamations](#)
- [Executive Orders](#)
- [Radio](#)

 [RSS Feeds](#)

**Major Speeches**

- [Press Conference](#)
- [Secure Fence Act](#)
- [Military Commissions](#)
- [Safe Port Act](#)
- [School Safety](#)

**Interact**

- [Ask the White House](#)
- [White House](#)
- [Interactive](#)

**Your Government**

December 5, 2006 | Last Updated 2:17 p.m. (EST)

**Press Briefing by Tony Snow**

Today's Press Briefing with White House Press Secretary Tony Snow has concluded. Video from the Press Briefing will be available on the web

site shortly.

**President Bush Meets with Secretary of Defense Nominee Robert Gates**

President Bush on Tuesday said, "Bob Gates will be a fine Secretary of Defense. I appreciate the fact that he's getting a hearing today in the United States Senate. I hope for a speedy confirmation so he can get sworn in and get to work. ... Those who wear the uniform know they'll have a friend in Bob Gates in the Defense Department. He admires our military; he respects those who have volunteered to serve our country." [full story](#)

**President Bush Meets with United Nations Ambassador John Bolton**

President Bush on Monday said, "I received the resignation of Ambassador John Bolton. I accepted. I'm not happy about it. I think he deserved to be confirmed. .... We're going to miss you in this administration. You've been a stalwart defender of freedom and peace. You've been strong in your advocacy for human rights and human dignity. You've done everything that can be expected for an Ambassador." [full story](#)

**President Bush Meets with His Eminence Abdul-Aziz Al-Hakim, Leader of the Supreme Council for the Islamic Revolution in Iraq**

President Bush on Monday said, "I told His

President George W. Bush and Mrs. Laura Bush sit with children of deployed U.S. military personnel and watch a performance of "Willy Wonka" by members of The Kennedy Center Education Department in the East Room Monday, Dec. 4, 2006. White House photo by Eric Draper

**View webcast** ►

**Holidays at the White House**

The White House is celebrating 'Deck the Halls and Welcome All' throughout the holiday season. [Click here](#) to view photos and learn more about holiday decorations and events.

**Strong U.S. Economy**

Economic growth continues with 92,000 new jobs created in October. There have been over 6.8 million new jobs created since August of 2003, and the unemployment rate decreased to 4.4 percent, the lowest rate since May 2001. [Learn more about the President's pro-growth policies.](#)





# 2007

PRESIDENT | VICE PRESIDENT | FIRST LADY | MRS. CHENEY | NEWS  
Your Government | History & Tours | Kids | E-mail | En Español

**THE WHITE HOUSE**  
WASHINGTON  
PRESIDENT GEORGE W. BUSH

December 26, 2007

**The White House**

**IN FOCUS**

- Budget Management
- Defense
- Economy
- Education
- Energy
- Environment
- Global Diplomacy
- Gulf Coast
- Health Care
- Homeland Security
- Immigration
- Iraq
- Judicial Nominations
- Medicare
- Middle East
- National Security
- Pandemic Flu
- Patriot Act
- Veterans

[more issues](#)

**News**

- Current News
- Press Briefings
- Proclamations
- Executive Orders
- Radio

[more news](#)

**Interact**

Podcasts RSS Feeds

Last updated 3:46 p.m. (EST)

**LATEST NEWS**



[+ more photos](#) White House Photo by Chris Greenberg

President George W. Bush signs into law H.R. 2764, the Consolidated Appropriations Act 2008, also known as the omnibus, making appropriations for the Department of State, foreign operations, and related programs for the fiscal year ending September 30, 2008, and for other purposes, after boarding Air Force One Wednesday, Dec. 26, 2007. White House photo by Chris Greenberg

**President Bush Signs H.R. 2764 into Law**

Today, I signed into law H.R. 2764, legislation that will fund the Federal Government within the reasonable and responsible spending levels I proposed -- without raising taxes and without the most objectionable policy changes considered by the Congress. This law provides a down payment for the resources our troops need, without arbitrary timelines for withdrawal. The Congress should quickly take action next year to provide the remainder of the funding needed by our troops.

[President's Radio Address](#)

**FEATURES**

**Barney Cam VI: Holiday in the National Parks**



Watch the Latest **Barney Cam**

[CHOOSE A FORMAT](#)

[Holiday in the National Parks](#)

**Honoring Our Veterans**

Through the generations, America's men and women in uniform have defeated tyrants, liberated continents, and set a standard of courage and idealism for the entire world. Our Nation pays tribute to those who have proudly served in our Armed Forces.



[In Focus: Veterans](#)

**Helping Homeowners**

On December 20, 2007, President Bush signed the Mortgage Forgiveness Debt Relief Act of 2007, which helps homeowners in need of assistance avoid foreclosure. This will help





2008

July 30, 2008 Last updated 11:41 p.m. (EDT)

Latest News

 **IN FOCUS**

- [Afghanistan](#)
- [Africa](#)
- [Budget Management](#)
- [Defense](#)
- [Economy](#)
- [Education](#)
- [Energy](#)
- [Environment](#)
- [Global Diplomacy](#)
- [Gulf Coast](#)
- [Health Care](#)
- [Homeland Security](#)
- [Immigration](#)
- [International Trade](#)
- [Iraq](#)
- [Judicial Nominations](#)
- [Middle East](#)
- [National Security](#)
- [Veterans](#)

[more issues](#) →

News

- [Current News](#)
- [Press Briefings](#)
- [Proclamations](#)
- [Executive Orders](#)
- [Radio](#)

[more news](#) →

Interact

- [Ask the White House](#)
- [White House Interactive](#)

Your Government

- [President's Cabinet](#)
- [USA Freedom Corps](#)

 **LATEST NEWS**



[+ more photos](#) White House Photo by Joyce N. Boghosian

President George W. Bush, joined by Vice President Dick Cheney and members of the Cabinet, addresses his remarks Wednesday, July 30, 2008 in the Rose Garden at the White House, urging Congress to lift the ban on offshore exploration on the Outer Continental Shelf. White House photo by Joyce N. Boghosian

**President Bush Signs H.R. 5501, the Tom Lantos and Henry J. Hyde United States Global Leadership Against HIV/AIDS, Tuberculosis and Malaria Reauthorization Act of 2008**



President Bush on Wednesday said, "With this legislation, America is showing its tremendous regard for the dignity and worth of every human being. This afternoon, I want to speak directly to those around the world who have, or think they may have, HIV: A positive diagnosis does not have to be a reason for shame. So don't let shame keep you from getting tested or treated. Your life is treasured by the people who love you. It is precious in the eyes of God. It matters to the people of the United States."

-  [In Focus: HIV/AIDS](#)
-  [In Focus: Health Care](#)
-  [Fact Sheet: A Historic and Lifesaving Commitment to Fight HIV/AIDS](#)

**President Bush Meets with Cabinet Members**

[Press Briefing by Dana Perino](#)

Features

 **FEATURES**

 **Ask the White House**

[Discuss Energy](#)

Join Keith Hennessey, Assistant to the President for Economic Policy and Director of the National Economic Council, on Friday, August 1 at 1:00 PM to discuss the President's Energy policy.



[Submit a Question](#) →

 **Freedom Agenda**

The United States is committed to the advance of freedom and democracy as the great alternatives to repression and radicalism. The most powerful weapon in the struggle against extremism is the universal appeal of freedom. Freedom is the best way to unleash the creativity and economic potential of a nation, the only ordering of a society that leads to justice, and the only way to achieve and permanently protect human rights.



[In Focus: Freedom Agenda](#) →

 **Energy Security for the 21st Century**

America's prosperity depends on reliable, affordable and secure sources of energy. President Bush believes the power of technology and the innovative spirit of America will reduce our reliance on foreign sources of energy, which will help ensure a growing and prosperous America in the 21st Century.



[In Focus: Energy Security](#) →

 **Tax Relief**

President Bush's 2001 and 2003 tax relief fueled economic growth and reduced the marginal rate for every income tax bracket. By the end of last year, Americans would have paid an additional \$1.3 trillion in taxes had it not been for the President's tax relief. If the President's tax relief is allowed to expire at the end of 2010, Americans will pay about \$280 billion more in taxes each year. With the largest tax increase in history looming, Congress should make the President's tax relief permanent.



[In Focus: Tax Relief](#) →

 **International Trade**

America is economically stronger when we participate fully in the worldwide economy. When 95% of the potential customers for American products live outside the U.S., America must reject policies that would result in economic





*Your*  
**WEEKLY ADDRESS**

The President restates his commitment to small business as key to economic recovery—from the Recovery Act to Financial Stability to Health Reform—and pledges more to come.

[1](#) [2](#) [3](#) [4](#)



White House Photo, Lawrence Jackson, 10/24/09

## A NEW FOUNDATION



### The President's Plan for Health Insurance Reform

Cut through the rhetoric on health insurance reform. Read the essentials of the President's plan, and watch a video with highlights of his speech to Congress.

[BACK](#) | [NEXT](#)

## SEARCH *the* SITE

## PHOTO *of the* DAY



President Barack Obama prepares to speak to servicemen and women at Naval Air Station Jacksonville, in Jacksonville, Fla. Official White House Photo by Pete Souza, October 26, 2009

## THE BLOG

October 27, 2009 at 3:07 PM EDT

**The Smart Grid: Creating Jobs, Saving Energy and Cutting Electric Bills**

October 27, 2009 at 2:46 PM EDT

**Only A Few Days Left**

EPA Administrator Lisa Jackson has a special

## FEATURED LEGISLATION

**Veterans Health Care Budget Reform and Transparency Act**

Signed: Thursday, October 22, 2009

**Cash For Clunkers Extension**

Signed: Thursday, August 6, 2009



# 2010



## MIDDLE CLASS TAX CUTS *Held Hostage*

The President duly applauds the two Senate Republicans who broke the blockade on small business help. But he denounces attempts by Republicans to hold middle class tax cuts hostage for an additional tax cut for the wealthiest 2 percent of Americans.

Watch the Video

1 2 3 4



President Obama and his economic team, White House Photo, Pete Souza, 9/15/10

### FEATURED TOPICS



#### A Boost for Small Business

The President applauds Congress for finally breaking the partisan Republican blockade on help for small business that would strengthen our recovery.

Learn More

← BACK | NEXT →

### SEARCH the SITE

Search WhiteHouse.gov

Search

HealthCare.gov

Take health care into your own hands





2013

the WHITE HOUSE PRESIDENT BARACK OBAMA

☆☆☆☆ THE WHITE HOUSE WASHINGTON ☆☆☆☆

Get Email Updates | Contact Us

BLOG PHOTOS & VIDEO BRIEFING ROOM ISSUES the ADMINISTRATION the WHITE HOUSE our GOVERNMENT

## We Have Not Forgotten

President Obama promises American families that the tragedy in Newtown and his pledge to take action to reduce gun violence remain a top priority.

SEE THE PLAN WATCH THE SPEECH

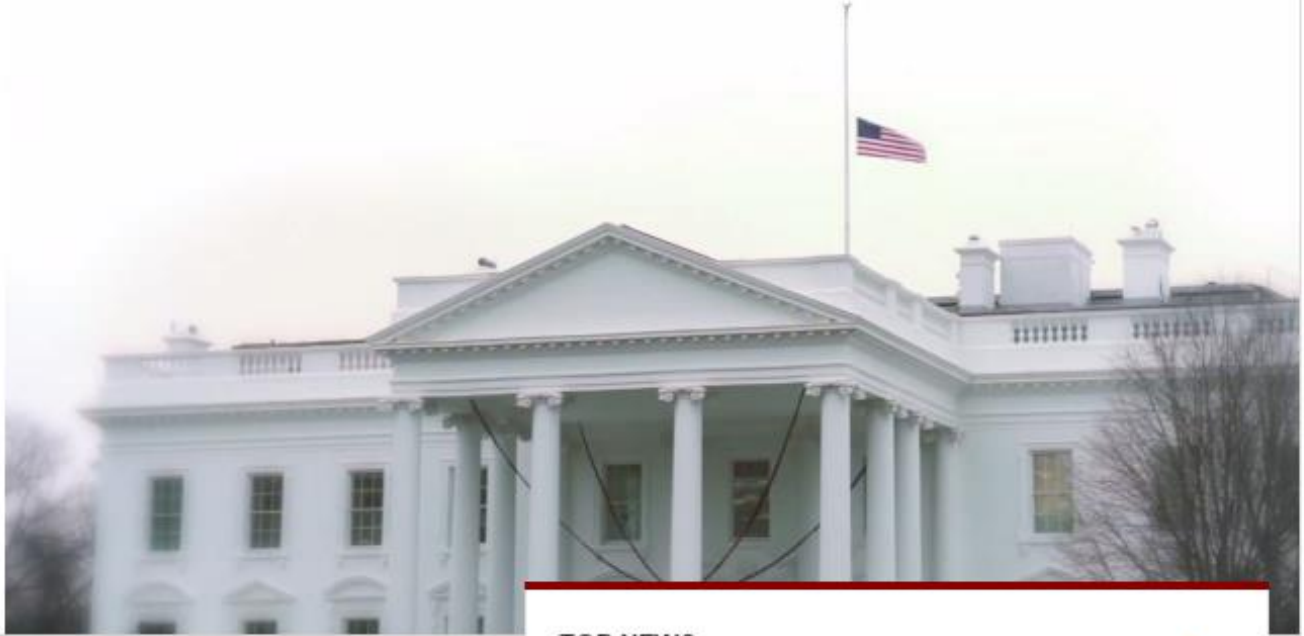

What are you looking for?

### POPULAR TOPICS



**A Balanced Plan**  
Learn about President Obama's plan to resolve harmful budget cuts and reduce the deficit.



**Immigration**  
Together we can build a fair, effective and common sense immigration system.



**Education**  
Preparing students for the jobs of the future starts with a strong school system

### TOP NEWS

March 29, 4:11pm  
In Miami, President Obama Talks About his Plan to Put People to Work Rebuilding America

March 28, 3:45pm  
President Obama: We Have Not Forgotten What Happened in Newtown

March 25, 3:00pm  
President Obama to new citizens: "In each of you, we see the true spirit of America"

### PHOTO OF THE DAY



ENGAGE SOCIAL NEWS INITIATIVES



# 2015

the WHITE HOUSE PRESIDENT BARACK OBAMA

Contact Us >

Get Email Updates >



BRIEFING ROOM

ISSUES

THE ADMINISTRATION

PARTICIPATE

1600 PENN



#### WHY DIPLOMACY MATTERS

### The President Chairs the Leaders' Summit on Countering ISIL and Violent Extremism

Watch President Obama open the Leaders' Summit on Countering ISIL and Violent Extremism at the United Nations.

FOLLOW ALONG

#### WHY DIPLOMACY MATTERS





# http://web.archive.org



<http://www.whitehouse.gov>

Go Wayback!

<http://www.whitehouse.gov> has been crawled 3,175 times going all the way back to [December 27, 1996](#).  
A crawl can be a duplicate of the last one. It happens about 25% of the time across 420,000,000 websites. [FAQ](#)

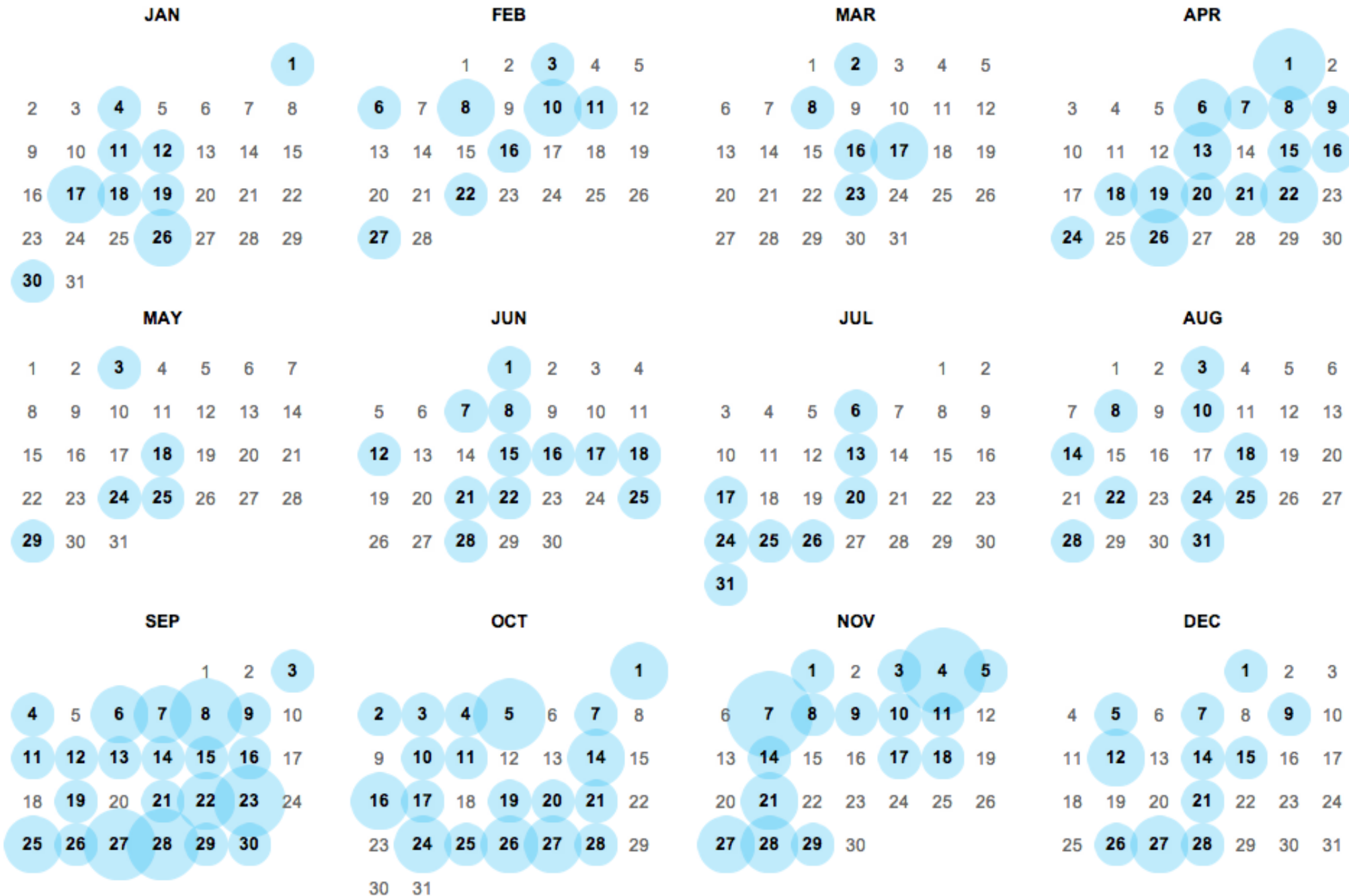
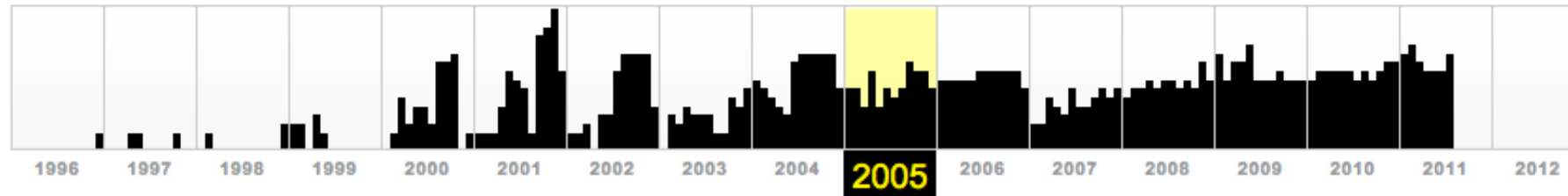



# Web Standards Bodies - W3C



- The World Wide Web Consortium (W3C):
  - the main international [standards organization](#) for the [World Wide Web](#)
  - Founded by [Tim Berners-Lee](#) at [MIT](#) and currently headed by him,
  - Maintains hundreds of standards associated with the Web, e-commerce, and information representation
- Standards known as *Recommendations* which proceed through successive *Drafts*

A recommendation progresses through five maturity levels:

Working Draft

Last Call Working Draft

Call for implementation

Call for Review of a Proposed Recommendation

[W3C Recommendation](#) (REC).



[Accessibility \(All\)](#)  
[Accessible Rich Internet Applications \(WAI-ARIA\)](#)  
[Audio](#)  
[Authoring Tool Accessibility Guidelines \(ATAG\)](#)  
[Best Practices for Authoring HTML](#)  
[CC/PP](#)  
[Content Transformation](#)  
[CSS](#)  
[CSS Mobile](#)  
[DCCI](#)  
[Declarative Web Applications](#)  
[Device Description Repository](#)  
[Device Independence Authoring](#)  
[DOM](#)  
[DOM events](#)  
[Efficient XML Interchange](#)  
[eGovernment](#)  
[Electronic Commerce](#)  
[Evaluation and Report Language \(EARL\)](#)  
[Geospatial](#)  
[Government Linked Data](#)  
[GRDDL](#)  
[Health Care and Life Sciences \(Semantic Web\)](#)  
[HTML](#)  
[HTML for User Agents](#)  
[HTTP](#)  
[InkML](#)  
[Internationalization \(All\)](#)  
[Internationalization of Web Architecture](#)  
[Internationalization of Web Design and Applications](#)  
[Internationalization of Web Services](#)  
[Internationalization of XML](#)  
[Javascript APIs](#)  
[MathML](#)  
[Media Access](#)  
[Mobile Web Applications](#)

[Mobile Web Authoring](#)  
[Mobile Web for Social Development](#)  
[Multimodal Web Applications](#)  
[OWL Web Ontology Language](#)  
[P3P](#)  
[PICS](#)  
[Plugins](#)  
[PNG](#)  
[POWDER](#)  
[Provenance](#)  
[Quality Assurance \(QA\) Framework](#)  
[RDF](#)  
[RDF Best Practices](#)  
[RDF Relationship to Other Formats](#)  
[RDF vocabularies](#)  
[RDFa](#)  
[RIF Rule Interchange Format](#)  
[Security for User Agents](#)  
[Security for Web Applications](#)  
[Semantic Annotation for WSDL and XML Schema](#)  
[Service Modeling Language \(SML\)](#)  
[SKOS](#)  
[SMIL](#)  
[SOAP](#)  
[SPARQL](#)  
[Stylesheets in XML](#)  
[SVG](#)  
[SVG Tiny](#)  
[Timed Text](#)  
[URI](#)  
[User Agent Accessibility Guidelines \(UAAG\)](#)  
[Voice](#)  
[Web and TV](#)  
[Web Architecture](#)  
[Web Components](#)  
[Web Content Accessibility Guidelines \(WCAG\)](#)  
[Web Fonts](#)

[Web IDL](#)  
[Web Real Time Communication](#)  
[Web Services Addressing](#)  
[Web Services Architecture](#)  
[Web Services Choreography](#)  
[Web Services Policy](#)  
[Web Services Resource Access](#)  
[WebCGM](#)  
[WICD](#)  
[Widgets](#)  
[WSDL](#)  
[XBL](#)  
[XForms](#)  
[XHTML 2](#)  
[XHTML For Mobile](#)  
[XHTML Modularization](#)  
[XInclude](#)  
[XKMS](#)  
[XLink](#)  
[XML](#)  
[XML Base](#)  
[XML Canonicalization](#)  
[XML Design Techniques](#)  
[XML Encryption](#)  
[XML Events](#)  
[XML Fragments](#)  
[XML Pipeline \(XProc\)](#)  
[XML Relationship to other formats](#)  
[XML Schema](#)  
[XML Signature](#)  
[XML-binary Optimized Packaging](#)  
[xml:id](#)  
[XPath](#)  
[XPointer](#)  
[XQuery](#)  
[XSL-FO](#)  
[XSLT](#)



# Web Standards Evolution

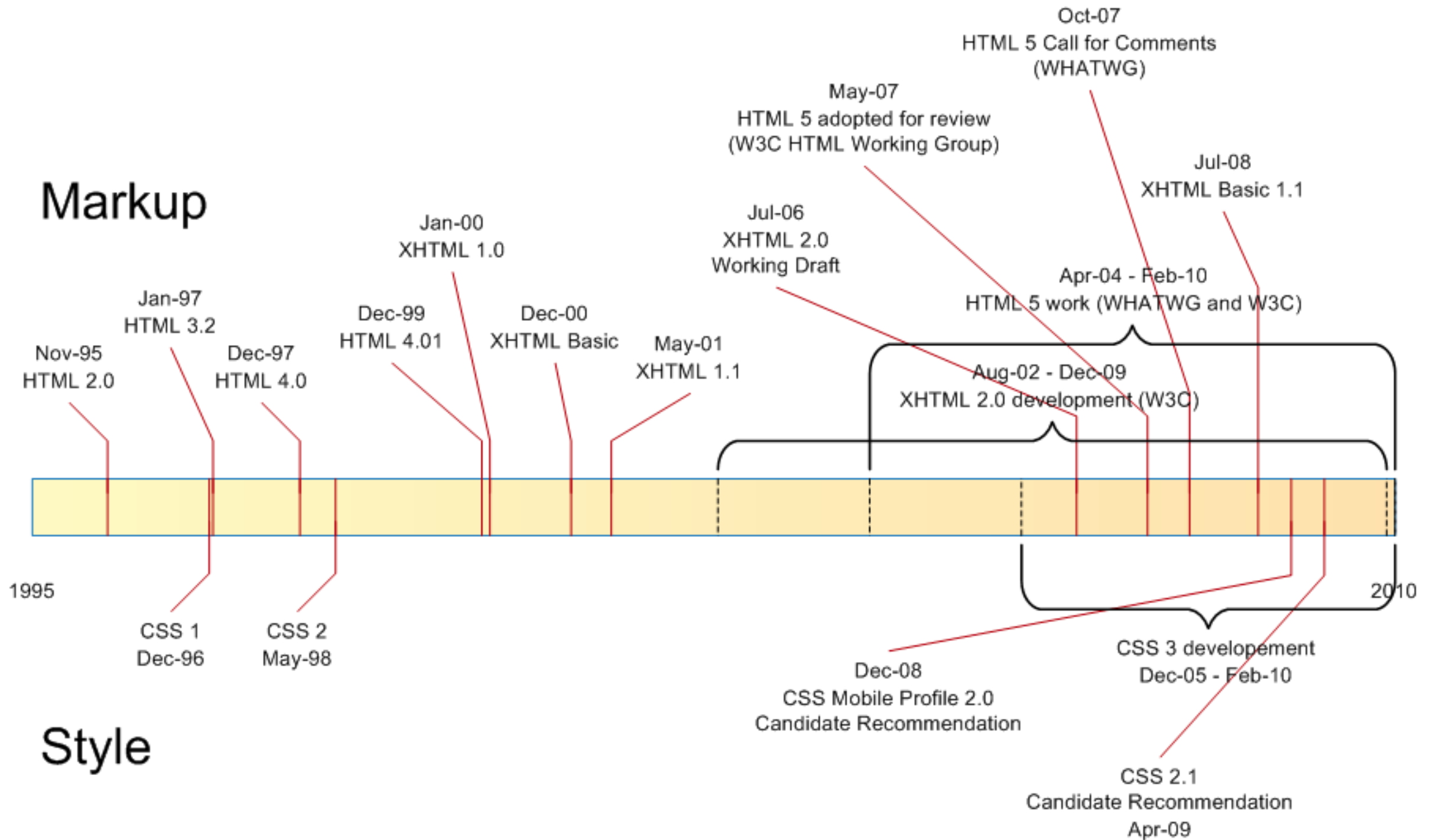



[Accessibility \(All\)](#)  
[Accessible Rich Internet Applications \(WAI-ARIA\)](#)  
[Audio](#)  
[Authoring Tool Accessibility Guidelines \(ATAG\)](#)  
[Best Practices for Authoring HTML](#)  
[CC/PP](#)  
[Content Transformation](#)  
[CSS](#)  
[CSS Mobile](#)  
[DCCI](#)  
[Declarative Web Applications](#)  
[Device Description Repository](#)  
[Device Independence Authoring](#)  
[DOM](#)  
[DOM events](#)  
[Efficient XML Interchange](#)  
[eGovernment](#)  
[Electronic Commerce](#)  
[Evaluation and Report Language \(EARL\)](#)  
[Geospatial](#)  
[Government Linked Data](#)  
[GRDDL](#)  
[Health Care and Life Sciences \(Semantic Web\)](#)  
[HTML](#)  
[HTML for User Agents](#)  
[HTTP](#)  
[InkML](#)  
[Internationalization \(All\)](#)  
[Internationalization of Web Architecture](#)  
[Internationalization of Web Design and Applications](#)  
[Internationalization of Web Services](#)  
[Internationalization of XML](#)  
[Javascript APIs](#)  
[MathML](#)  
[Media Access](#)  
[Mobile Web Applications](#)

[Mobile Web Authoring](#)  
[Mobile Web for Social Development](#)  
[Multimodal Web Applications](#)  
[OWL Web Ontology Language](#)  
[P3P](#)  
[PICS](#)  
[Plugins](#)  
[PNG](#)  
[POWDER](#)  
[Provenance](#)  
[Quality Assurance \(QA\) Framework](#)  
[RDF](#)  
[RDF Best Practices](#)  
[RDF Relationship to Other Formats](#)  
[RDF vocabularies](#)  
[RDFa](#)  
[RIF Rule Interchange Format](#)  
[Security for User Agents](#)  
[Security for Web Applications](#)  
[Semantic Annotation for WSDL and XML Schema](#)  
[Service Modeling Language \(SML\)](#)  
[SKOS](#)  
[SMIL](#)  
[SOAP](#)  
[SPARQL](#)  
[Stylesheets in XML](#)  
[SVG](#)  
[SVG Tiny](#)  
[Timed Text](#)  
[URI](#)  
[User Agent Accessibility Guidelines \(UAAG\)](#)  
[Voice](#)  
[Web and TV](#)  
[Web Architecture](#)  
[Web Components](#)  
[Web Content Accessibility Guidelines \(WCAG\)](#)  
[Web Fonts](#)

[Web IDL](#)  
[Web Real Time Communication](#)  
[Web Services Addressing](#)  
[Web Services Architecture](#)  
[Web Services Choreography](#)  
[Web Services Policy](#)  
[Web Services Resource Access](#)  
[WebCGM](#)  
[WICD](#)  
[Widgets](#)  
[WSDL](#)  
[XBL](#)  
[XForms](#)  
[XHTML 2](#)  
[XHTML For Mobile](#)  
[XHTML Modularization](#)  
[XInclude](#)  
[XKMS](#)  
[XLink](#)  
[XML](#)  
[XML Base](#)  
[XML Canonicalization](#)  
[XML Design Techniques](#)  
[XML Encryption](#)  
[XML Events](#)  
[XML Fragments](#)  
[XML Pipeline \(XProc\)](#)  
[XML Relationship to other formats](#)  
[XML Schema](#)  
[XML Signature](#)  
[XML-binary Optimized Packaging](#)  
[xml:id](#)  
[XPath](#)  
[XPointer](#)  
[XQuery](#)  
[XSL-FO](#)  
[XSLT](#)





# Web Standards Bodies -WHATWG

---

- The Web Hypertext Application Technology Working Group is a community of people interested in evolving [HTML](#) and related technologies.
- The WHATWG was founded by individuals from [Apple](#), the [Mozilla Foundation](#) and [Opera Software](#) in 2004
- The WHATWG was formed in response to the slow development of web standards monitored by the [World Wide Web Consortium](#) (W3C), and its decision to abandon HTML in favor of [XML](#)-based technologies.
- The WHATWG has a small, invitation-only steering committee called "Members"





# Welcome to the WHATWG community

*Maintaining and evolving HTML since 2004*

## HTML

Read, use, or implement  
the HTML Living Standard

## Web Dev Edition

An edition of the HTML specification  
designed specifically for Web Developers

## Join

Comment on the HTML standard and  
send proposals of your own

## News

Read and contribute  
to the WHATWG blog

## Help

Send questions and help others  
in the [help@whatwg.org](mailto:help@whatwg.org) mailing list

## Forums

Talk with Web designers  
about how to write HTML

## FAQ

Get answers to your questions  
about HTML and the WHATWG

## Specs

See the other specifications  
developed at the WHATWG

## IRC

Chat with other members  
of the WHATWG community



# W3C Web Standards Process

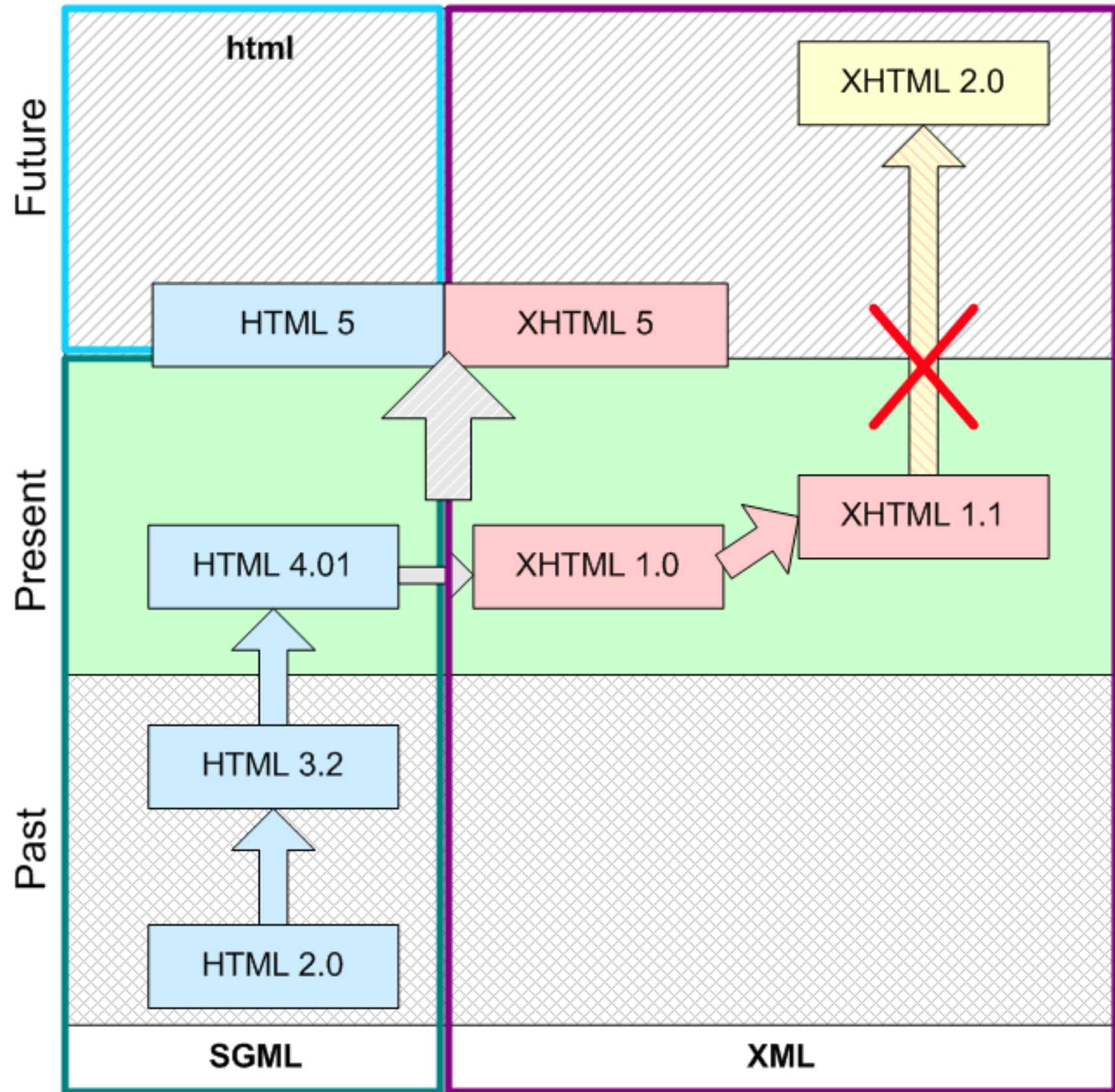





Vs



- 
- The [Mozilla Foundation](#) and [Opera Software](#) presented a position paper at a W3C workshop in June 2004 focusing on developing technologies that are backwards compatible with existing browsers
  - The workshop concluded with a vote, 8 for, 14 against, for continuing work on HTML
    - W3C proceed with its XHTML 2.0 Effort
    - Work based upon that position paper moved to the WHATWG, and was soon renamed HTML5

<http://www.w3.org/> -- 7 March 2007 -- Recognizing the importance of an open forum for the development of the predominant Web content technology, W3C today invites browser vendors, application developers, and content designers to help design the next version of HTML by participating in the new [W3C HTML Working Group](#). Based on significant input from the design and developer communities within and outside the W3C Membership, W3C has [chartered](#) the group to conduct its work in public and to solicit broad participation from W3C Members and non-Members alike.

"HTML started simply, with structured markup, no licensing requirements, and the ability to link to anything. More than anything, this simplicity and openness has led to its tremendous and continued success," explained Tim Berners-Lee, W3C director and inventor of HTML. "It's time to revisit the standard and see what we can do to meet the current community needs, and to do so effectively with commitments from browser manufacturers in a visible and open way."

- In 2007, W3C abandoned its XHTML 2.0 effort, offered to merge its working group with WHATWG, and adopted the HTML5 specifications as the starting point for a W3C HTML5 effort

*"It's time to revisit the standard and see what we can do to meet the current community needs, and to do so effectively with commitments from browser manufacturers in a visible and open way."*

*Tim Berners-Lee*



# Standardization Timetable

---

- 2008:W3C/WHATWG published the First Public Working Draft of the specification
  - *2011: 'Last Call' an invitation to communities inside and outside W3C to confirm the technical soundness of the specification*
  - *2014: Target date for a 'Recommendation'*
- However: in 2012, WHATWG and W3C decided on a degree of separation.
  - *W3C will continue the HTML5 specification work, focusing on a single definitive standard,*
  - *This is considered as a "snapshot" by WHATWG.*
  - *The WHATWG organization will continue its work with HTML5 as a "Living Standard". The concept of a living standard is that it is never complete and is always being updated and improved*

# HTML5

Taxonomy & Status (December 2011)

- W3C Recommendation
- Candidate Recommendation
- Last Call
- Working Draft
- Non-W3C Specifications
- Deprecated W3C APIs

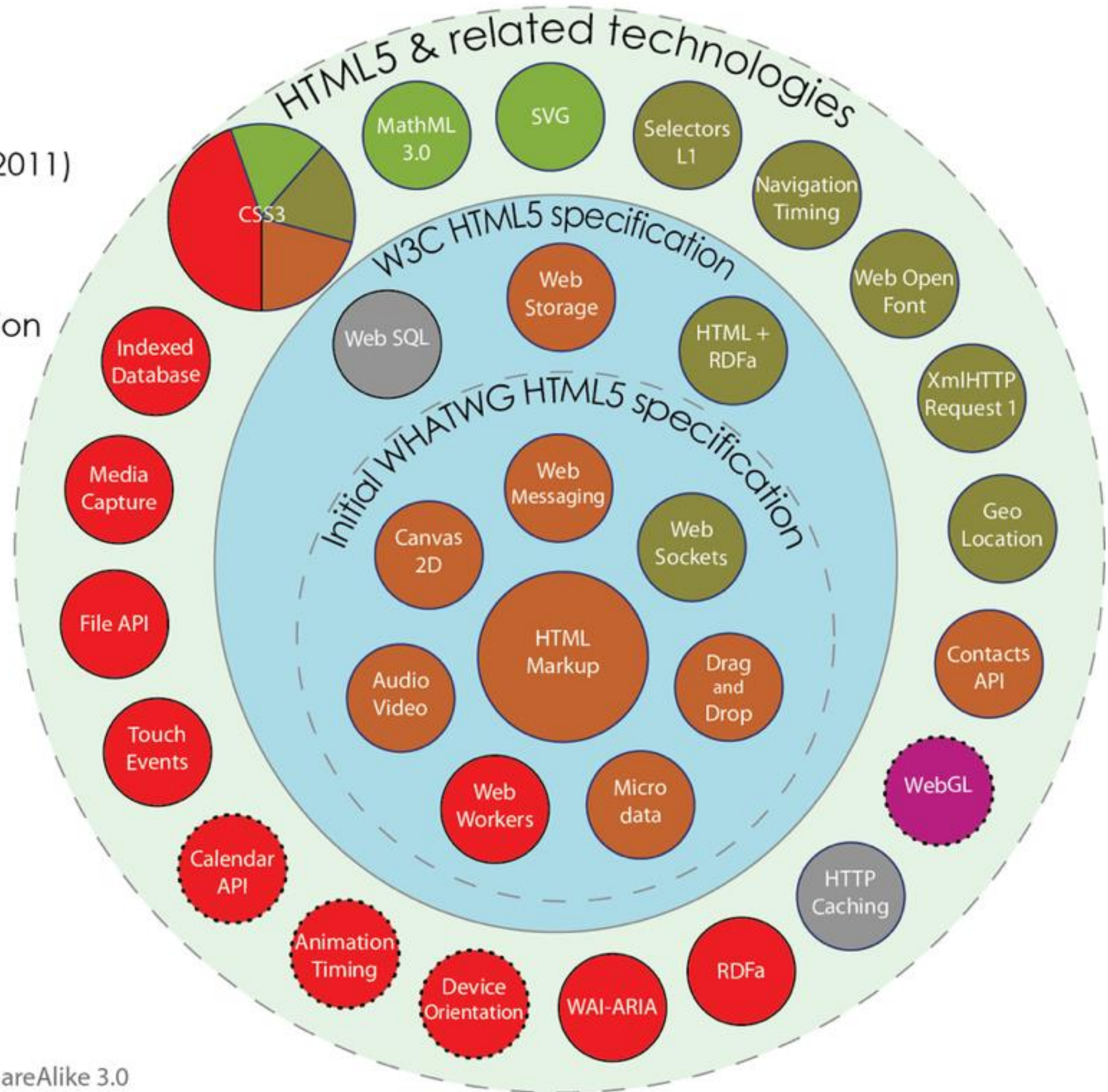

By Sergey Mavrody 2011 | CC Attribution-ShareAlike 3.0



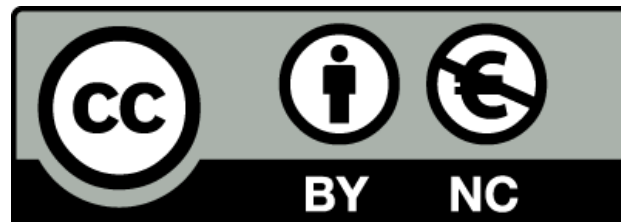

Except where otherwise noted, this content is licensed under a [Creative Commons Attribution-NonCommercial 3.0 License](http://creativecommons.org/licenses/by-nc/3.0/).

For more information, please see <http://creativecommons.org/licenses/by-nc/3.0/>

